

BT-3 160 EEC (510316000)

GENERAL DATA



CENTRIFUGAL FAN IN STEEL CASING WITH ELECTRIC MOTOR EEC

MANUFACTURING FEATURES

- Casing made of polymer coated steel, totally air tightness for outdoor installation.
- EC motors enable integration of several fans into a unified networks and their centralized control.
- Backward impeller with high efficient electronically commutated (EC) direct current motor with external rotor. Turbine is dynamically balanced while assembly.
- Motors are equipped with ball bearings for longer service life of the fan (40.000 hours). IP 44 motor protection index.

APPLICATIONS

- Designed for supply and exhaust ventilation and air conditioning systems for various premises requiring cost-effective solution and controllable ventilation.
- Inside or outside duct installation.
- EC motors reduce energy demand by about 35% and ensure high aerodynamic performance and low noise level. Specially designed for ventilation of public premises such as:
 - banks
 - supermarkets
 - restaurants
 - hotels
- Its use is also contemplated in installations close to residential buildings and for domestic applications, such as the ventilation of private swimming pools.

PERFORMANCE CURVE

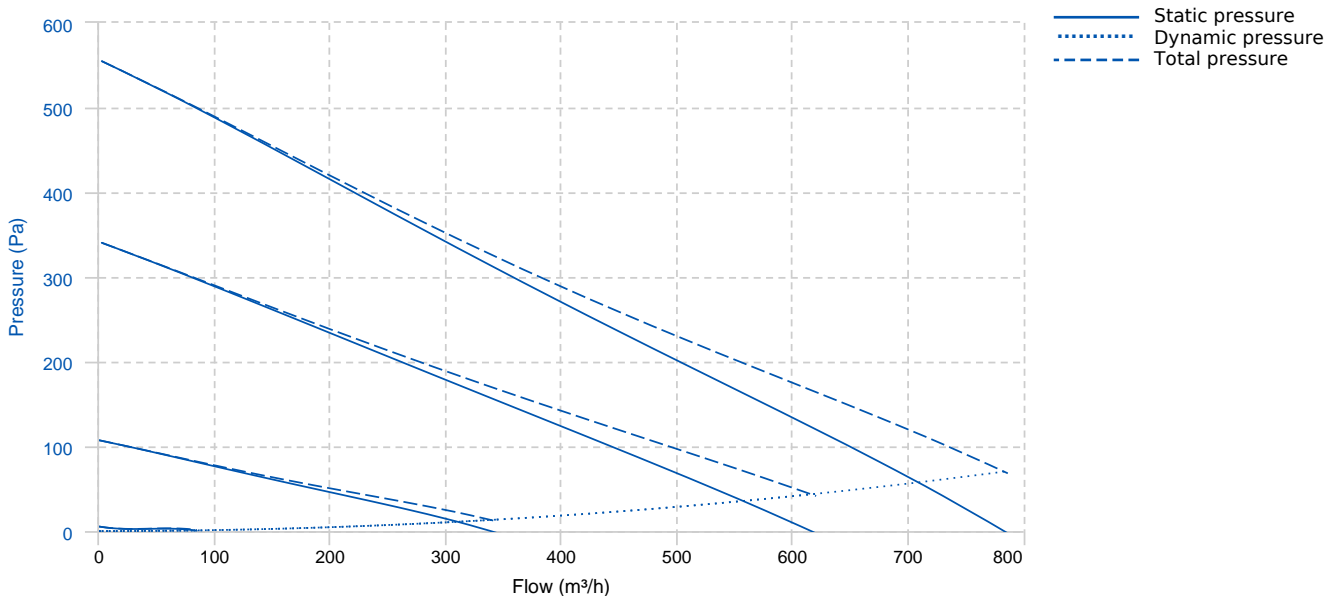

TECHNICAL DATA

Fan

Approx. weight 4.32 kg Max. Flow 785 m³/h

Motor

Power 0.11 kW RPM 2800 I max. (230V) 0,90 A

DIMENSIONS

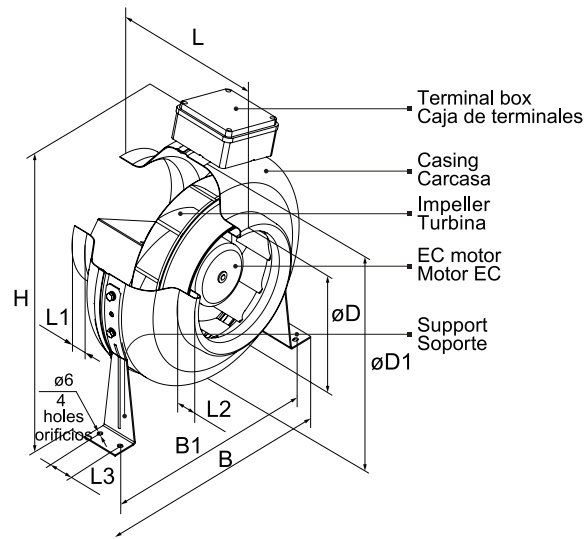

Dimensions (mm)

B	360	B1	320	H	365	L	220	L1	25
L2	25	L3	30	ØD	159	ØD1	305		

WIRING DIAGRAM

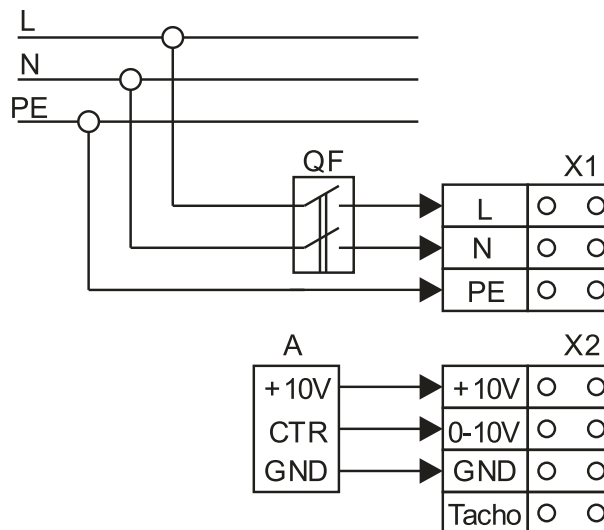

ACCESSORIES



SAFETY SWITCH
INT 25 3P A
REF: INT253PA



ANTI-VIBRATION JOINT
JE 45
REF: 300719201



SPEED CONTROLLER FOR EEC MOTOR
REGC
REF: FX263300



CIRCULAR SOUND ATTENUATOR IN GALVANISED STEEL
SILC-MINI 160
REF: SILCM160