

ENKELROOF-A 220 EEC (ENKRAEC220)

GENERAL DATA

ROOF FAN WITH ALUMINIUM COWL

MANUFACTURING FEATURES:



- Protection cowl made of anticorrosive treated aluminum easily removable for motor and impeller maintenance.
- Structure in anticorrosive galvanized steel and support frame for adaptation to the roof with anti-bird protection grid.
- High-efficiency backward-curved blade impeller with self-cleaning system. Reinforced polyamide impeller for models 155, 190 and 220. The rest of the models in aluminum.
- EC technology uses integral electronic control to ensure that the motor always runs at optimal load and ensures efficient energy utilization. It incorporates an external rotor EC motor with high efficiency and low noise level. Speed control through a 0-10V or PWM signal. 230V 50/60Hz single-phase power supply for models 155 to 310 and 400V 50/60Hz three-phase power supply for sizes 355 and 450. IP54 and motor class B insulation.

APPLICATIONS

Designed for deck or roof mounting, they are indicated for:

- Smoke extraction.
- Air renewal in all types of buildings and industries.
- Working temperature range from -25°C to 60°C.

UNDER REQUEST

- Fan (size between 250 and 450) with k-factor reading.

PERFORMANCE CURVE

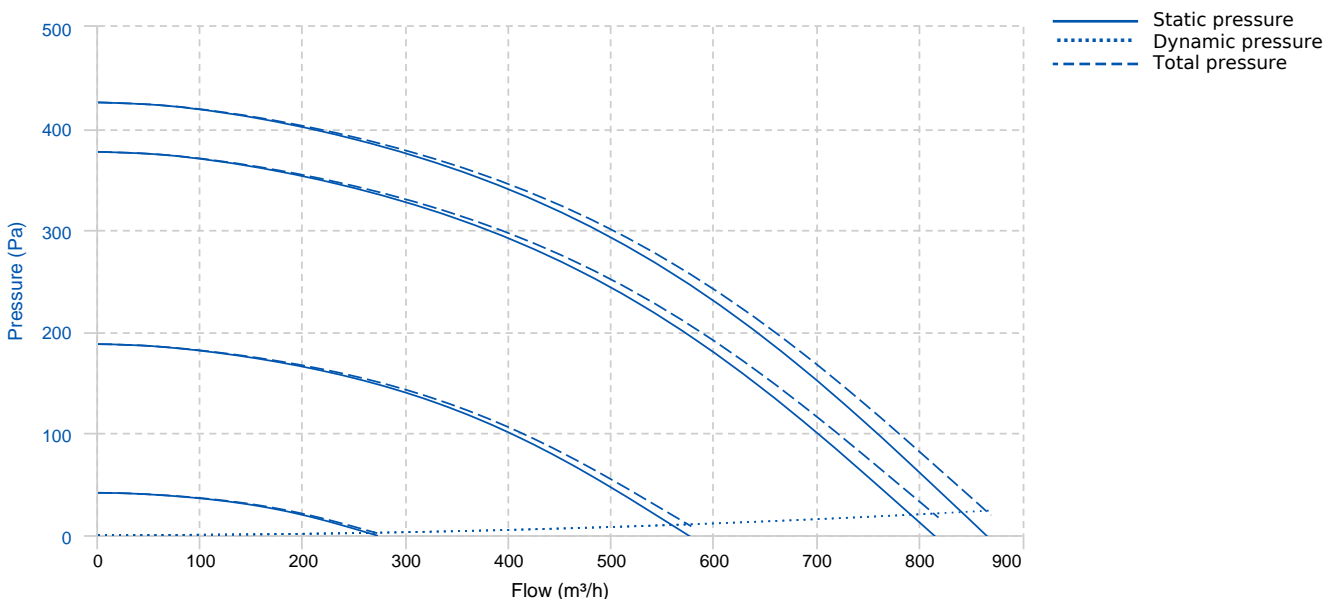

TECHNICAL DATA

Fan							
RPM	2600	Approx. weight	7 kg	Max. Flow	870 m ³ /h		
Motor							
Power	0.075 kW	RPM	2600	I max. (230V)	0,6 A	Approx. weight	1.4 kg

DIMENSIONS

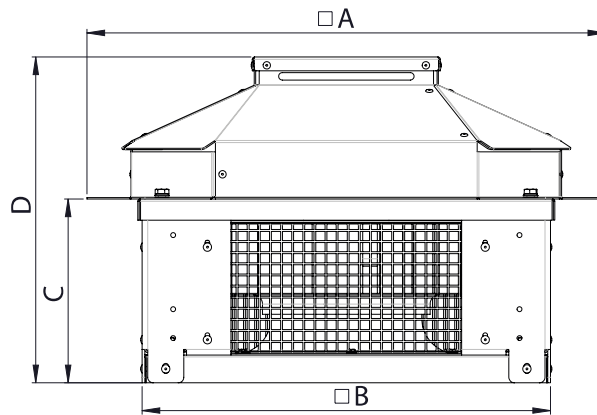

Dimensions (mm)

A	565	B	441	C	113.5	D	273,5
---	-----	---	-----	---	-------	---	-------

WIRING DIAGRAM

Nº	Signal Señal	Colour Color	Specification Especificación
1	L	Brown Marrón	AC 220V/50Hz
2	N	Blue Azul	AC 220V/50Hz
3	Pe	Yellow-Green Amarillo-Verde	

Nº	Signal Señal	Colour Color	Specification Especificación
1	GND	Blue Azul	
2	Vsp	Yellow Amarillo	0-10 V/PWM
3	Vcc	Red Rojo	DC 10V
4	FG	White Blanco	1 Pulse/R

ACCESSORIES



**CONNECTION FLANGE
AC 200**
REF: 960003206



**CIRCULAR-CIRCULAR ANTI-VIBRATION FLANGE
BAD 6 (Ø200)**
REF: 960003456

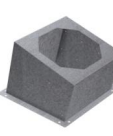

**INCLINED ROOF FAN SUPPORT
BTI 410**
REF: 50870410XX



**CIRCULAR SOUND ATTENUATOR IN GALVANISED
STEEL**
SILC-MINI 200 C
REF: SILCM200C



**SPEED CONTROLLER FOR EEC MOTOR
REGC**
REF: FX263300



**SPEED CONTROLLER WITH SAFETY SWITCH FOR
EEC MOTOR**
PMR 25A
REF: PMREEC



**ENKELROOF VERTICAL DISCHARGE
KV ENKELROOF 220**
REF: KVENKR220

SPARE PARTS

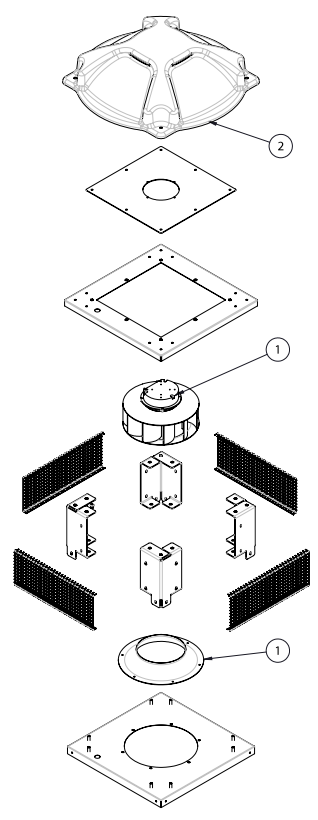



	Code	Model	Qty
1	241253017	MOTOR-FAN+INLET CONE 220 220V 50-60Hz	x1
2	279254478A	ROOF COWL ENKELROOF-A 220-250	x1