

HJBM 56 1,5kW EEC (1500rpm) (268561103)

GENERAL DATA



WALL MOUNTED FAN WITH SQUARE FRAME, VARIABLE PITCH BLADES AND ELECTRONIC MOTOR

MANUFACTURING FEATURES

- Square plate made of galvanized steel sheet.
- Variable pitch angle polyamide impeller reinforced with fibreglass.
- Supplied with motor support and protection guard according to the ROHS 2002/95/EC Directive (Restriction of the Use of Certain Hazardous Substances in Electrical and Electronic Equipments).
- PM brushless motor (permanent magnets), synchronous, electronically commutated, high efficiency and low sound level. Specially designed for fans with electronic operation and control in deported box IP65.

Working range: from 400 to 1200-2000rpm (depending on the models)

Motor with IP54 protection and class F insulation. IP 65 drive case

Power: 220V \pm 10% single phase

Power frequency: 50 / 60Hz

Operating temperature range: -20°C to 50°C

Speed control through signal 0-10V or PWM

APPLICATIONS

Designed for wall assembly, they are suitable for:

- Air renewal for all kind of buildings and industries.

UNDER REQUEST

- B form impeller (air flow from impeller to motor).
- Aluminium impeller.

PERFORMANCE CURVE

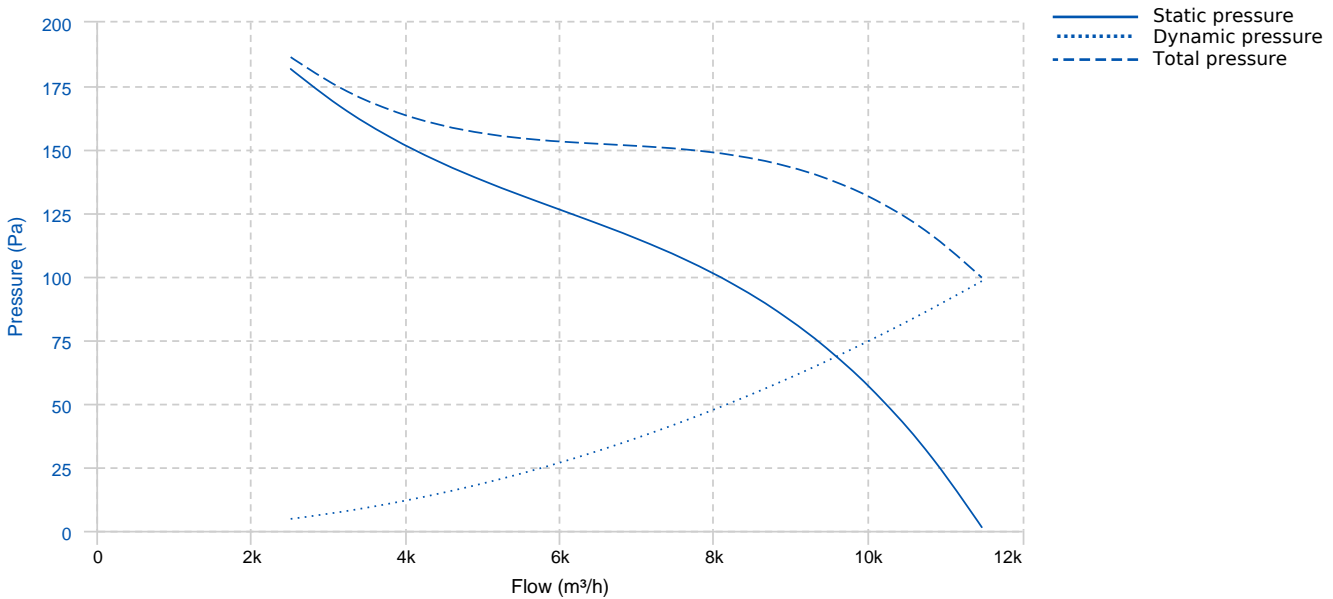

TECHNICAL DATA

Fan							
RPM	1500	Approx. weight	22 kg	Max. Flow	11480 m ³ /h		
Motor							
Power	1,5 kW	RPM	1500	I max. (230V)	10 A	Approx. weight	0 kg

ERP DATA

Fan data sheet		
Fan type	Axial fan	
Installation category	A: Outlet and Inlet free discharge	
Efficiency category	Static	
The fan has to be installed with VF	No	
Motor power (kW)	1.5	
	Fan values	ERP Requirements 2015
Max. efficiency (%)	41.75	32.08
Efficiency grade (N)	49.67	40
Pabs (kW)	0.56	
Flow (m ³ /h)	7158.42	
Static pressure (Pa)	112.91	
Speed (m/s)	1500	
Specific ratio	1.00	

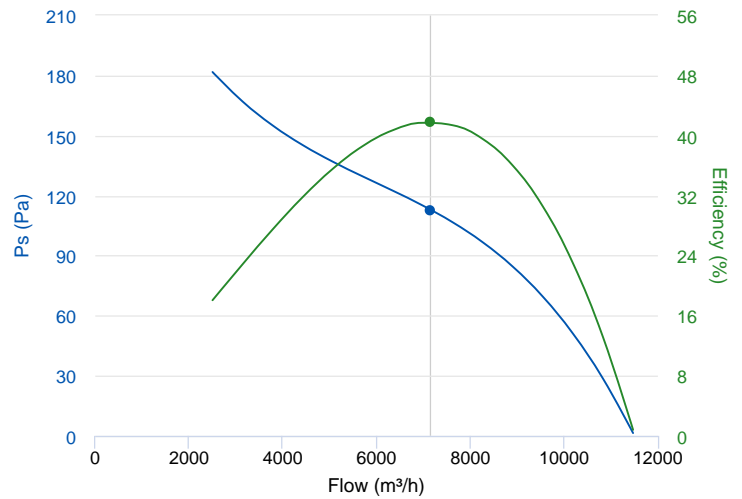

DIMENSIONS

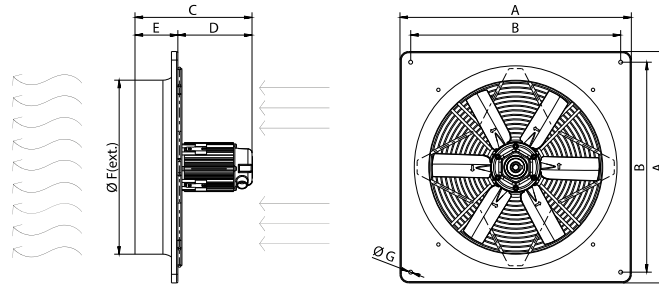

Dimensions (mm)

A	725	B	650	C	290	D	170	E	120
ØF	563	ØG	11						

WIRING DIAGRAM

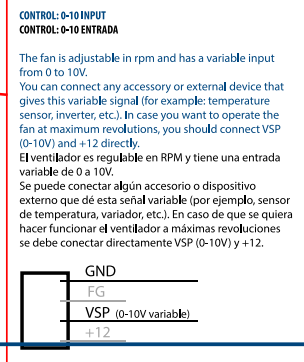
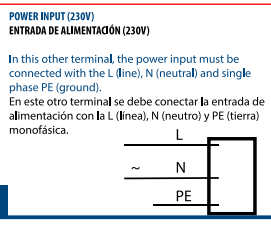
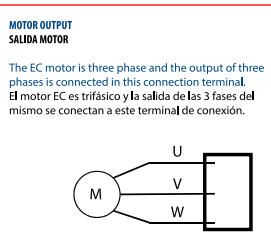

ACCESSORIES



SAFETY SWITCH
INT 25 3P A
REF: INT253PA



Outlet protection guard for axial fans
RPO 56
REF: 980000056



PLASTIC GRAVITY SHUTTER
PCP 56
REF: 963250105



SPEED CONTROLLER FOR EEC MOTOR
REGC
REF: FX263300



ALUMINIUM GRAVITY SHUTTER
PC2 60
REF: PC26060

SPARE PARTS

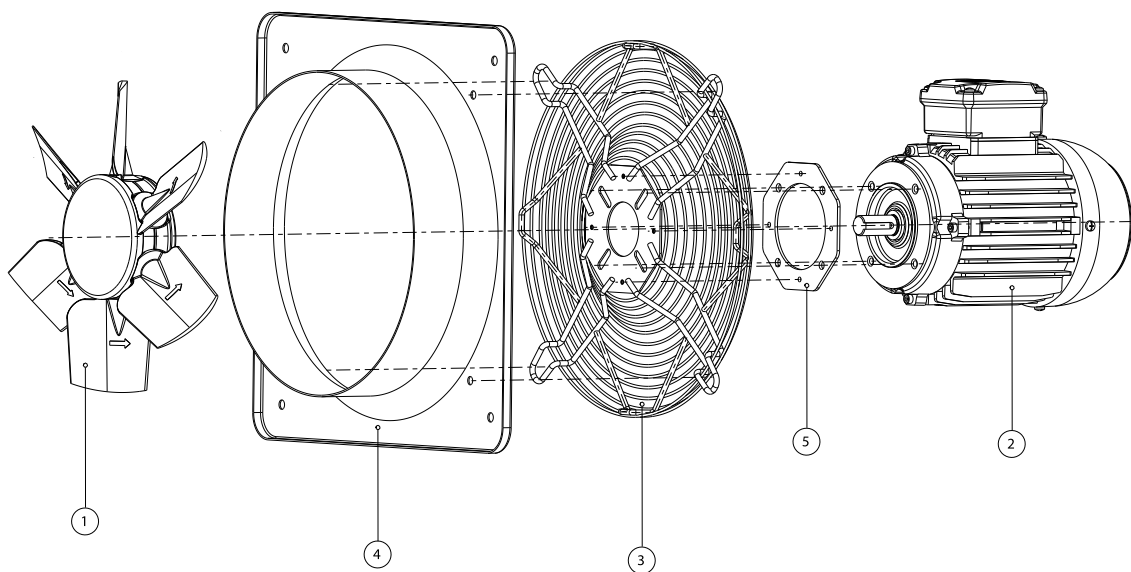

	Code	Model	Qty
1	H56006440PSTD	IMPELLER 560:AP0:6 G40 D24	x1
3	268561906	PROTECTION GRID HJBM EEC56	x1